

# Rack Options & Accessories . . .

## Key Locking Steel or Aluminum Rack Drawers



**All rack options offered by Star Case are EIA Compliant and Adapt to All 19" EIA Racks**

## Heavy-Duty Rack Shelves



## Rack Rail, Rack Fasteners, Support Systems, Shock Isolators and more . . .



Blank Filler Panels



Shock Isolators



Rack Fasteners



Rack Component Support System

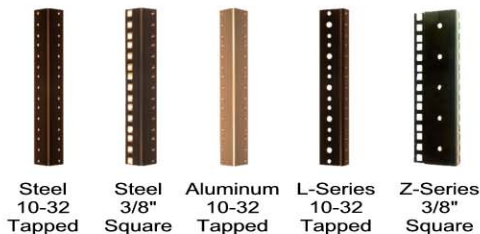

## Star Case Manufacturing Co., LLC

648 Superior Ave.  
Munster, IN 46321  
(219)922-4440 FAX: (219)922-4442  
(800)822-STAR  
(800)782-CASE

web: [www.starcasemfg.com](http://www.starcasemfg.com) e-mail: [star@starcasemfg.com](mailto:star@starcasemfg.com)

# Star Case

Manufacturing Co., LLC

**Since 1975**

**The Best IT Solutions**

*Racks, Frames, Racks, Enclosures*

*& Kits & Kits*



*Rack Shipping*

*Cases*

*Rack Rail*

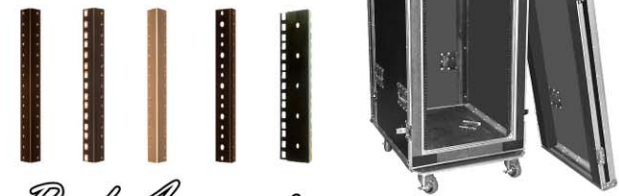

*Rack Accessories*

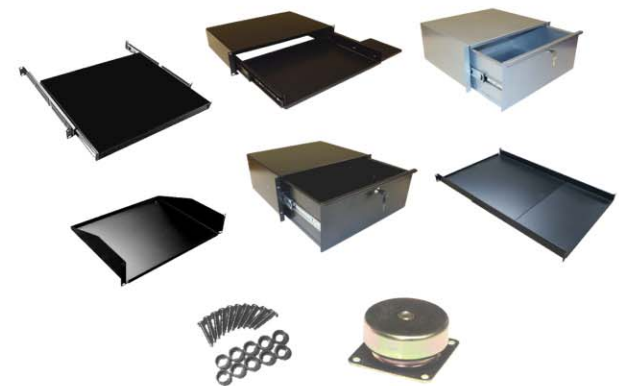

**All in Quick Ship  
Stock or Custom Sizes**

# Designer Series Rack Enclosures & Kits



## Electronics Racks Enclosures & Frames

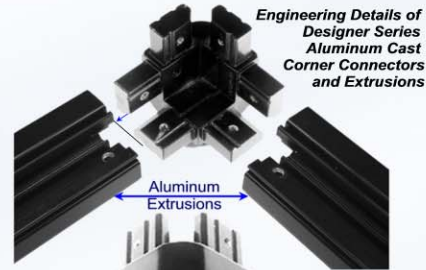

Engineering Details of Designer Series Aluminum Cast Corner Connectors and Extrusions

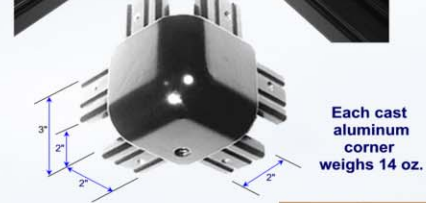

Each cast aluminum corner weighs 14 oz.

### Exploded Structural View

Racks in 4 popular heights (48, 36, 24 & 12RU) and 3 popular depths (20, 24 & 30") with optional front and/or rear key-locking smoked acrylic doors

### Rail Extrusion Details

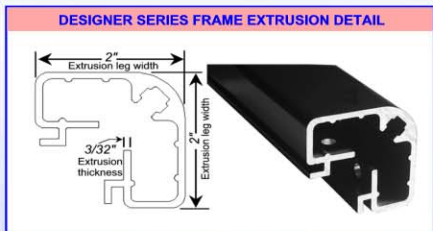
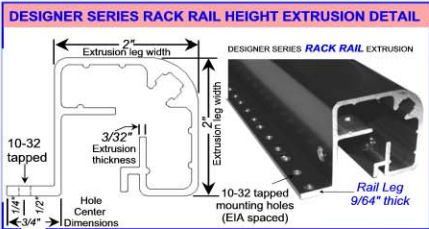

Now Available Knocked Down or Factory Assembled - Same Low Price!

EXTRUDED RACK RAILS (Protectively packaged in "HEIGHT" Pack) (10-32 tapped holes)

Designer Series Racks are now available in any rack height from 2RU - 48RU\*\* (3-1/2" - 84")

\*\* 1RU (rack unit) is equal to 1-3/4". To determine rack outside height add 4" plus leveling feet or caster elevation to rackable height.

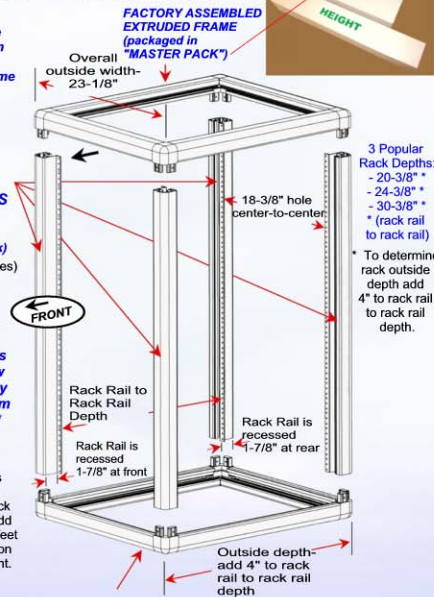

FACTORY ASSEMBLED EXTRUDED FRAME (packaged in "MASTER PACK")

# Professional Series Racks & Frames



Machine tool makers rely on countersinking -- using screws with cone-shaped heads -- tightened into mated cone-shaped holes -- for an extremely rigid assembly that will not move.

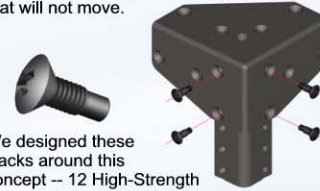

We designed these Racks around this concept -- 12 High-Strength Dog Point Screws, countersunk into specially engineered, High-Strength Aluminum Alloy "Corner Connectors".

### Rack Kit Contents (shown-RF2420)



### Material Details

**Aluminum Rack Rails**  
3.7 mm (0.1457")  
10-32 Tapped

**Aluminum Cast Corners**  
*Chemistry Data*  
Si: <12%  
Cu: <3.5%  
Mg: <0.3%  
Cu: <0.1%  
Mg: <1.3%  
Fe: <1.3%  
Mn: <0.5%  
Zn: <5.0%  
Ni: <0.5%  
Fe: <0.4%  
Mn: <0.7%  
Cr: <0.2%  
Ti: <0.06%  
Zr: <0.2%  
Balance is Aluminum (powder coated)

**Dog Point Screws**  
Grade 8, High Strength Steel  
10-32x5/8" (120,000-150,000) psi  
C33-C39 Rockwell Hardness  
Corrosion Resistant Finish

10-32 Tapped Holes 172 Kit Sizes

Front & Top View of Popular Professional Series Rack (RF0820) showing how cast connecting corners affect actual width, depth & height rail lengths

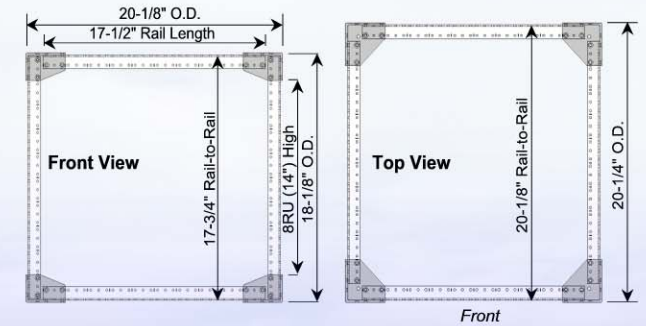

# "Quick Ship" Rackmount Shipping Cases

- in stock, ready to ship - 4U thru 26U - custom heights to 45U - multiple depths
- many with casters - locking recessed latches - ATA construction
- multiple recessed handles - shockmount & non-shockmount styles

